

Data Sheet

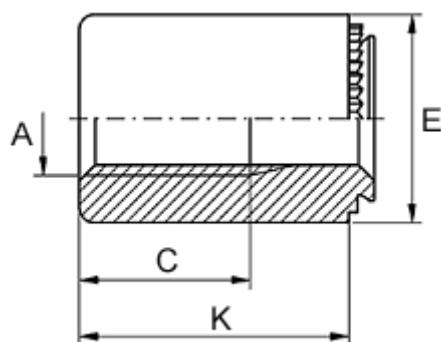

Article number: 12516800340500
Description: KLEE-coil 516 800 340.500
M4 Stainless 1.4305

Measures



Female thread A	= M4
Height K	= 16
Min distance to edge	= 4.0
Outer diameter E	= 8
Plate thickness	= from 2.4
Recommended bore diameter +0.05	= 5.00
Thread length	= 8.0